

# 6FM120X 12V 120Ah(10hr)

The rechargeable batteries are lead-lead dioxide systems. The dilute sulfuric acid electrolyte is absorbed by separators and plates and thus immobilized. Should the battery be accidentally overcharged producing hydrogen and oxygen, special one-way valves allow the gases to escape thus avoiding excessive pressure build-up. Otherwise, the battery is completely sealed and is, therefore, maintenance-free, leak proof and usable in any position.



## Battery Construction

Component	Positive plate	Negative plate	Container	Cover	Safety valve	Terminal	Separator	Electrolyte
Raw material	Lead dioxide	Lead	ABS	ABS	Rubber	Copper	Fiberglass	Sulfuric acid

## General Features

- Absorbent Glass Mat (AGM) technology for efficient gas recombination of up to 99% and freedom from electrolyte maintenance or water adding.
- Not restricted for air transport-complies with IATA/ICAO Special Provision A67.
- UL-recognized component.
- Can be mounted in any orientation.
- Computer designed lead, calcium tin alloy grid for high power density.
- Long service life, float or cyclic applications.
- Maintenance-free operation.
- Low self discharge.

## Dimensions and Weight

Length(mm / inch)	330 / 12.99
Width(mm / inch)	171 / 6.73
Height(mm / inch)	215 / 8.46
Total Height(mm / inch)	222 / 8.74
Approx. Weight(Kg / lbs)	32.5 / 71.6

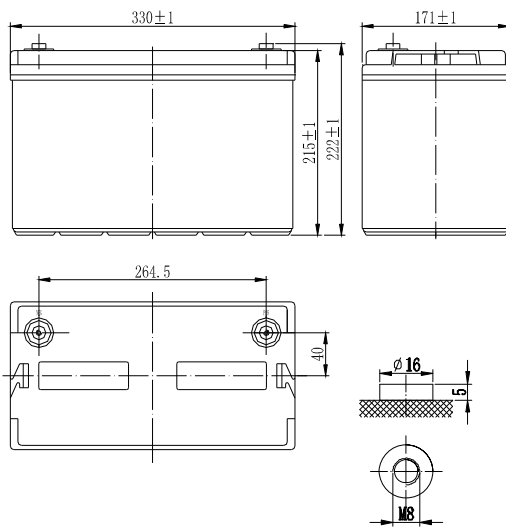

## Performance Characteristics

Nominal Voltage	12V
Number of cell	6
Design Life	10 years
Nominal Capacity 77°F(25°C)	
10 hour rate (12.0A, 10.8V)	120Ah
5 hour rate (18.7A, 10.5V)	93.5Ah
1 hour rate (71.6A, 9.6V)	71.6Ah
Internal Resistance	
Fully Charged battery 77°F(25°C)	4mOhms
Self-Discharge	
3% of capacity declined per month at 20°C(average)	
Operating Temperature Range	
Discharge	-20~60°C
Charge	-10~60°C
Storage	-20~60°C
Max. Discharge Current 77°F(25°C)	950A(5s)
Short Circuit Current	2250A
Charge Methods: Constant Voltage Charge 77°F(25°C)	
Cycle use	2.30-2.35VPC
Maximum charging current	36A
Temperature compensation	-30mV/°C
Standby use	2.23-2.27VPC
Temperature compensation	-20mV/°C

## Discharge Constant Current (Amperes at 77°F25°C)

End Point Volts/Cell	10min	15min	30min	1h	3h	5h	10h	20h
1.60V	250	203	120	71.6	28.9	19.2	12.4	6.55
1.65V	237	195	116	71.1	28.3	19.0	12.3	6.50
1.70V	223	187	112	69.7	27.7	18.8	12.2	6.44
1.75V	210	179	108	67.5	27.1	18.7	12.1	6.38
1.80V	197	171	106	65.4	26.3	18.5	12.0	6.30

## Discharge Constant Power (Watts at 77°F25°C)

End Point Volts/Cell	10min	15min	30min	45min	1h	2h	3h	5h
1.60V	449	370	227	157	145	77.8	56.1	38.1
1.65V	426	358	220	153	143	76.4	55.4	37.9
1.70V	404	346	213	150	141	75.0	54.8	37.6
1.75V	383	334	206	146	137	73.6	54.1	37.4
1.80V	358	322	199	143	133	72.9	53.2	37.0

(Note)The above characteristics data are average values obtained within three charge/discharge cycles not the minimum values.

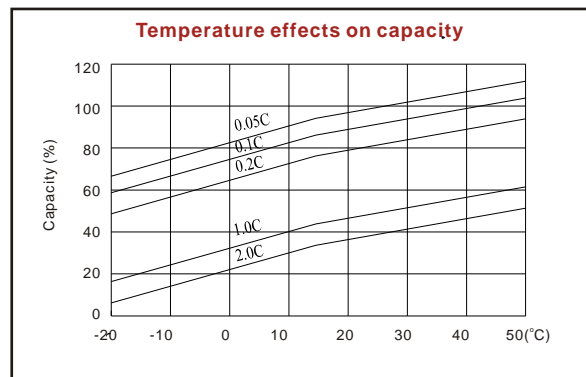
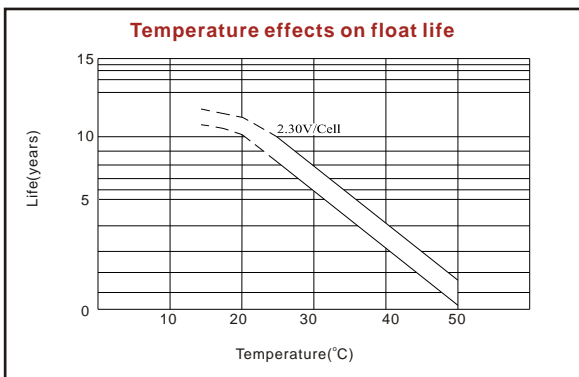
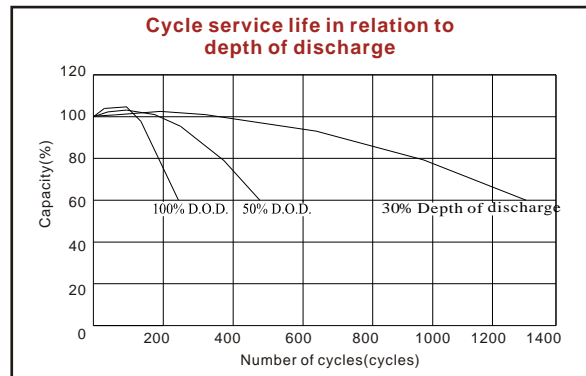
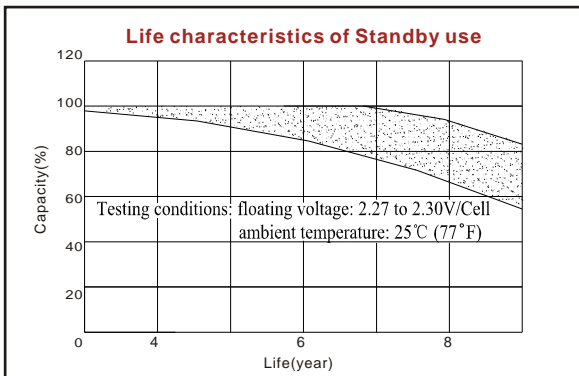
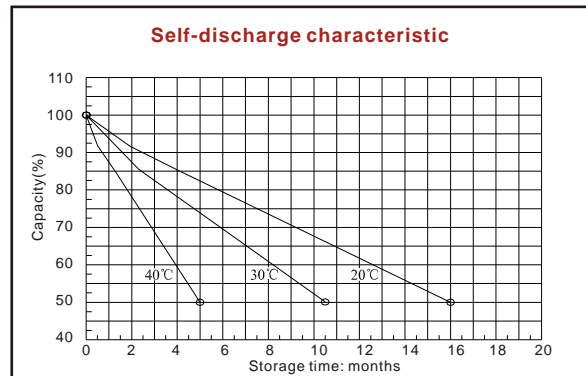
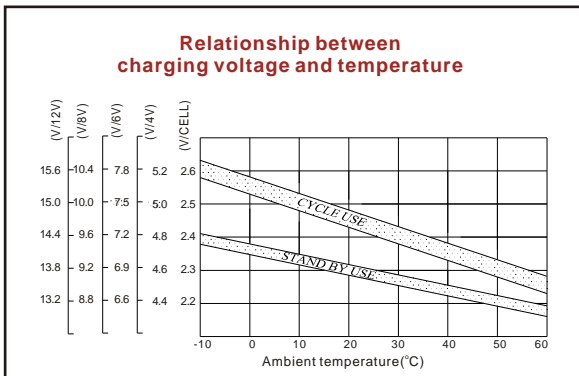
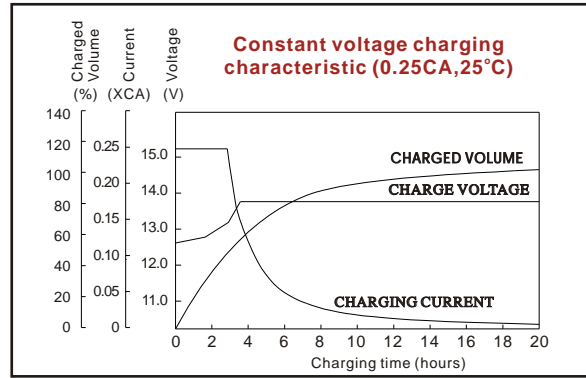
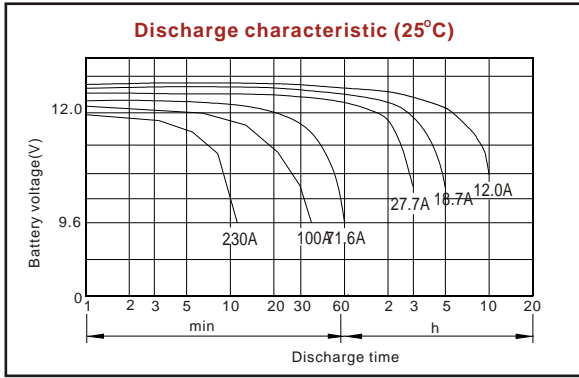

ISO9001:2000

MH25860

G4M19906-9202-E-16

[www.vision-batt.com](http://www.vision-batt.com)

**Shenzhen Center Power Tech. Co., Ltd.**  
 Center Power Industrial Park, Tongfu Industrial District Dapeng Town, 518120 Shenzhen, China  
 Tel: (+86-755) 8431 8088 Fax: (+86-755) 8431 8038 E-mail: sales@vision-batt.com