

6FM150HX 12V 150Ah(10hr)



The rechargeable batteries are lead-lead dioxide systems. The dilute sulfuric acid electrolyte is absorbed by separators and plates and thus immobilized. Should the battery be accidentally overcharged producing hydrogen and oxygen, special one-way valves allow the gases to escape thus avoiding excessive pressure build-up. Otherwise, the battery is completely sealed and is, therefore, maintenance-free, leak proof and usable in any position.

Battery Construction

Component	Positive plate	Negative plate	Container	Cover	Safety valve	Terminal	Separator	Electrolyte
Raw material	Lead dioxide	Lead	ABS	ABS	Rubber	Copper	Fiberglass	Sulfuric acid

General Features

- Absorbent Glass Mat (AGM) technology for efficient gas recombination of up to 99% and freedom from electrolyte maintenance or water adding.
- Not restricted for air transport-complies with IATA/ICAO Special Provision A67.
- UL-recognized component.
- Can be mounted in any orientation.
- Computer designed lead, calcium tin alloy grid for high power density.
- Long service life, float or cyclic applications.
- Maintenance-free operation.
- Low self discharge.

Dimensions and Weight

Length(mm / inch)	482±2 / 18.98±2
Width(mm / inch)	170±1 / 6.69±1
Height(mm / inch)	242±2 / 9.53±2
Total Height(mm / inch)	242±2 / 9.53±2
Approx. Weight(Kg / lbs)	47 / 103.6

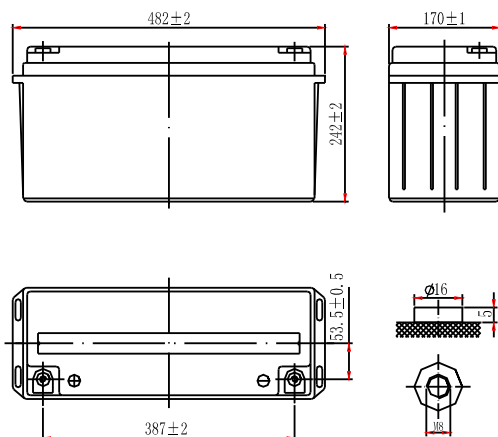

Performance Characteristics

Nominal Voltage	12V
Number of cell	6
Design Life	10 years
Nominal Capacity 77°F(25°C)	
10 hour rate (15.0A, 10.8V)	150Ah
5 hour rate (26.5A, 10.5V)	132.5Ah
1 hour rate (102A, 9.6V)	102Ah
Internal Resistance	
Fully Charged battery 77°F(25°C)	3.5mOhms
Self-Discharge	3% of capacity declined per month at 20°C(average)
Operating Temperature Range	
Discharge	-20~60°C
Charge	-10~60°C
Storage	-20~60°C
Max. Discharge Current 77°F(25°C)	1000A(5s)
Short Circuit Current	2800A
Charge Methods: Constant Voltage Charge 77°F(25°C)	
Cycle use	14.4-14.7V
Maximum charging current	45A
Temperature compensation	-30mV/°C
Standby use	13.6-13.8V
Temperature compensation	-20mV/°C

Discharge Constant Current (Amperes at 77°F25°C)

End Point Volts/Cell	5min	10min	15min	30min	1h	3h	5h	10h	20h
1.60V	450	351	285	165	102	41.2	28.0	15.9	8.20
1.65V	419	330	270	160	100	40.3	27.6	15.7	8.14
1.70V	388	309	256	155	98	39.5	27.1	15.5	8.08
1.75V	356	289	242	149	95	38.6	26.5	15.3	8.00
1.80V	320	266	228	146	92	37.5	26.0	15.0	7.88

Discharge Constant Power (Watts at 77°F25°C)

End Point Volts/Cell	5min	10min	15min	30min	45min	1h	2h	3h	5h
1.60V	765	609	501	325	221	201	112	78.0	53.5
1.65V	734	579	483	315	216	198	110	77.1	53.2
1.70V	686	548	465	306	211	195	108	76.2	52.8
1.75V	638	519	446	296	206	190	106	75.3	52.5
1.80V	591	487	425	286	202	184	105	74.0	52.0

(Note)The above characteristics data are average values obtained within three charge/discharge cycles not the minimum values.

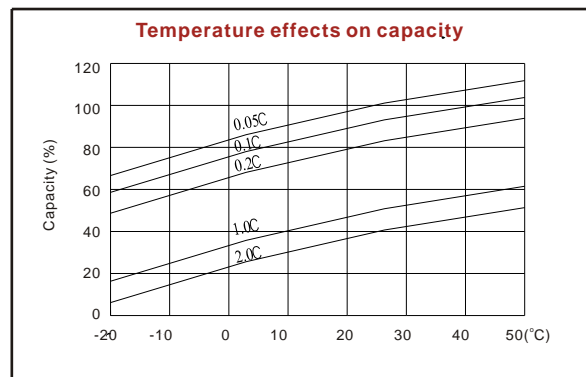
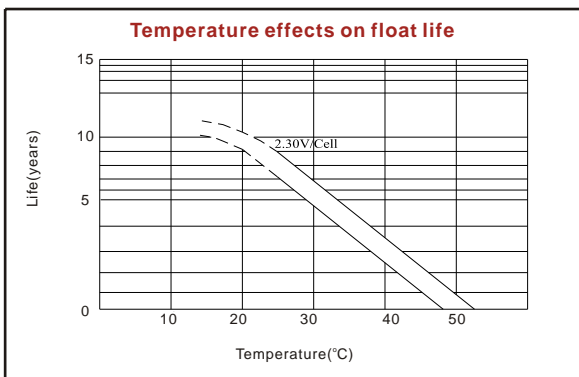
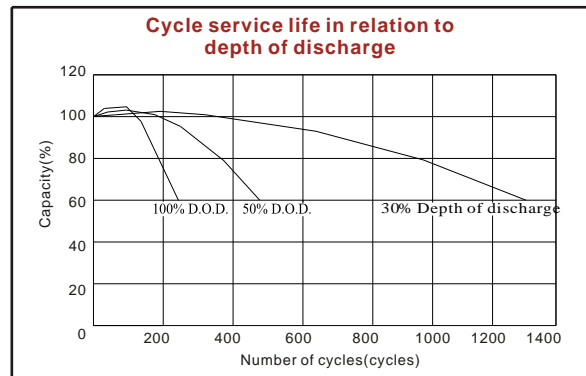
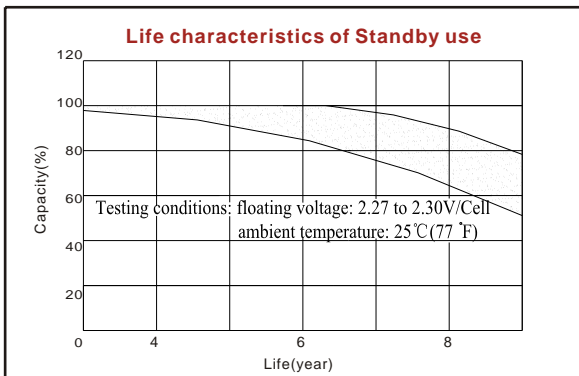
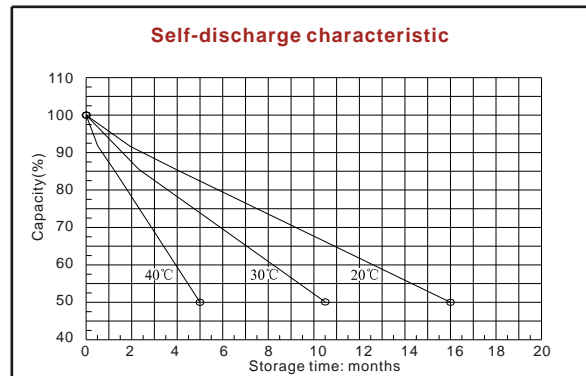
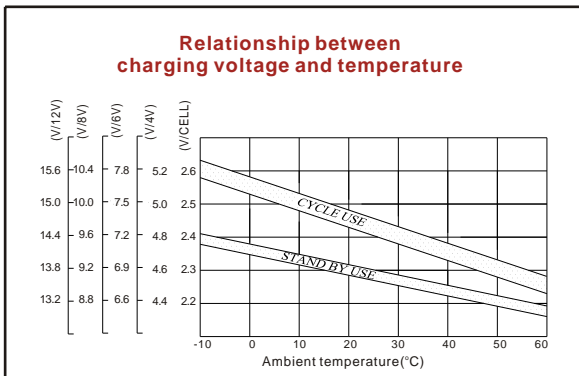
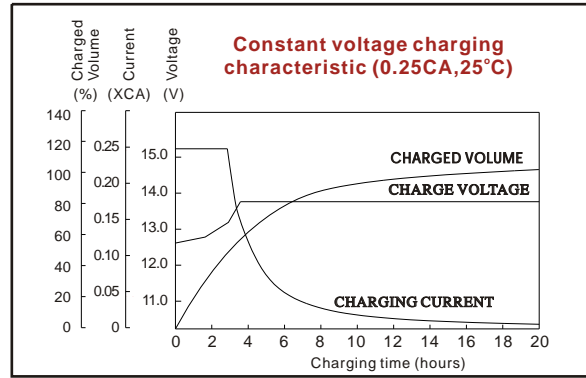
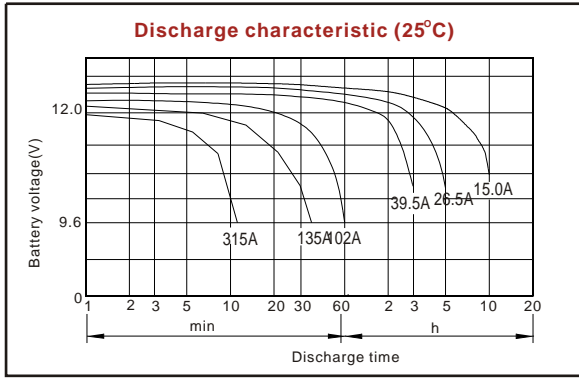

ISO9001:2000

MH25860

G4M19906-9202-E-16

Shenzhen Center Power Tech. Co., Ltd.
 Center Power Industrial Park, Tongfu Industrial District Dapeng Town, 518120 Shenzhen, China
 Tel: (+86-755) 8431 8088 Fax: (+86-755) 8431 8038 E-mail: sales@vision-batt.com

www.vision-batt.com